



Industrie Service

# EU TYPE-EXAMINATION CERTIFICATE

According to Annex IV, Part A of 2014/33/EU Directive

**Certificate No.:** EU-OG 184

**Certification Body of the Notified Body:** TÜV SÜD Industrie Service GmbH  
Westendstr. 199  
80686 Munich – Germany  
Identification No. 0036

**Certificate Holder:** P.F.B. s.r.l.  
Via Raimondo Dalla Costa, 690  
41122 Modena – Italy

**Manufacturer of the Test Sample:** P.F.B. s.r.l.  
Via Raimondo Dalla Costa, 690  
41122 Modena – Italy  
(Manufacturer of Serial Production – see Enclosure)

**Product:** Overspeed governor, detecting and tripping element fixed at the overspeed governor, as a part of the protection device against overspeed for the car moving in upwards direction and tripping element against unintended car movement

**Type:** LK 300

**Directive:** 2014/33/EU

**Reference Standards:** EN 81-20:2014  
EN 81-50:2014  
EN 81-1:1998+A3:2009  
EN 81-2:1998+A3:2009

**Test Report:** EU-OG 184 of 2016-04-07

**Outcome:** The safety component conforms to the essential health and safety requirements of the mentioned Directive as long as the requirements of the annex of this certificate are kept.

**Date of Issue:** 2016-04-07

**Date of Validity:** from 2016-04-20

Achim Janocha  
Certification Body "lifts and cranes"



**Annex to the EC Type-Examination Certificate  
No. EU-OG 184 of 2016-04-07**



Industrie Service

**1 Scope of application**

1.1 Generally

1.1.1 Driving rope

Category Round strand rope made of steel wire  
Diameter 6 – 8 mm

1.1.2 Tension forces (force produced by the tensioning weight, acting on the axis of rope deviating pulley)

Tension force determined in the test [N] (New rope and groove)	Tensile force in	
	Down direction [N]	Up direction [N]
583	736	—
1020	1619	451

Retraction of the safety gear in both directions of rotation permissible.  
The safety component can fulfil three security features (1.2, 1.3 and 1.4).

1.2 Using as an overspeed governor – permissible speeds

Permissible tripping speed 0.40 – 3.37 m/s  
Permissible rated speed ≤ 2.93 m/s

1.3 Using as a part of the protection device against overspeed for the car moving in upwards direction

The overspeed governor can be used as a part of the protection device against overspeed for the car moving in upwards direction. Monitoring of upward speed will be done by overspeed governor itself and a braking device can be triggered (engaged) via the overspeed governor's electric safety device or mechanically.

1.4 Using as a part of the protection device against unintended car movement by an installed anti-creep protection

Using **with / without** detection system (activation by detection system till a permissible tripping speed according 1.2 or at each stopping)

Maximum possible response distance\*\* 260 mm

Maximum response time\* of retaining solenoid and power supply unit 11 ms

Execution power supply unit Type NPS\_50V

\*Response time: Defined as the difference in time between current drop of the power supply for the solenoid retaining the blocking device and achieving the end position for the activation of the safety gear.

\*\*Response distance: Defined as the max. distance that can be covered by the lift moving away from the landing position after the blocking device has engaged and as caused by delay and/or other distance losses at the overspeed governor until the tensile force has built up.

**2 Terms and Conditions**

2.1 Above mentioned safety component represents only a part at the protection device against overspeed for the car moving in upwards direction and unintended car movement. Only in combination with a braking respectively detecting component in accordance with the standard, which must be subjected to an own type-examination, can the system created fulfil the requirements for a protection device.

2.2 The adjusted tripping speed and the safety switch must be sealed against unauthorized adjustment (safety switch e.g. by colour sealing of the fastening bolts).

**Annex to the EC Type-Examination Certificate  
No. EU-OG 184 of 2016-04-07**



Industrie Service

- 2.3 Positioning of the overspeed governor vertical with rocker above pulley. Rope deflection optional (but at least 180° angle of wrap).
- 2.4 The triggering of the safety device according 1.4 takes place by interruption of the energy supply to the magnetic coin of anti creep protection. This is not caused positive mechanically but electrically resp. electromagnetically by interruption of the energy supply to the magnetic coin of anti creep protection. However, the mechanical engagement of the device has to be absolutely guaranteed after the electrical safety device has responded. In light of the above, the device must be made to engage at regular intervals (e.g. once a day or automatically at each landing) so that the anchor plate can be checked for correct closing (e.g. micro switches resp. proximity switch). If the anchor plate do not perform correctly (anchor fail to close) the lift must be kept at standstill.
- 2.5 If activation of anti-creep according 1.4 will take place by every operational stop of the lift, this activation shall be initiated with car stands still.
- 2.6 The installer of the complete lift must create an examination instruction to fulfil the overall concept of the protection device, add it to the lift documentation and provide any necessary tools or measuring devices, which allow a safe examination (e. g. with closed landing doors).
- 2.7 Fast and safe rescuing of lift passengers must be possible by suitable technical measures under all circumstances. It must be documented in the operation manual of the lift.
- 2.8 The identification drawing LK\_300 or LK\_A\_DE including stamp dated 2016-04-07 shall be included to the EU type-examination for the identification and information of the general construction and operation and distinctness of the approved type.
- 2.9 The EU type-examination certificate may only be used in combination with the corresponding annex and enclosure (List of authorized manufacturer of the serial production). The enclosure will be updated immediately after any change by the certification holder.

### 3 Remarks

- 3.1 Considering the whole protection systems, it is necessary to include time need and impact of build-up the tensile force as well as spread and change over time, perhaps possible distances and/or time delay caused by mechanical deflections.
- 3.2 Possible design variants (also in combination):
- Design with or without testing groove
  - Preliminary switch off
  - Remote release
  - Protection against lowering
  - Safety switch with electrical resetting
  - Attachment pulse encoder
  - Protection device against rope leaving the pulley
  - Protection cover
  - Magnetic sensor
- 3.3 The overspeed governor can also be used to a counterweight in compliance with the permissible tripping speed.
- 3.4 This EU type-examination certificate was issued according to the following standards:
- EN 81-1:1998 + A3:2009 (D), Annex F.4, F.7 and F.8
  - EN 81-2:1998 + A3:2009 (D), Annex F.4 und F.8
  - EN 81-20:2014 (D), part 5.6.2.2.1.7, part 5.6.6.11 and part 5.6.7.13
  - EN 81-50:2014 (D), part 5.4, 5.7 and 5.8

A revision of this EU type-examination certificate is inevitable in case of changes or additions of the above mentioned standards or of changes of state of the art.

**Enclosure to the EU Type-Examination Certificate  
No. EU-OG 184 of 2016-04-07**



Industrie Service

**Authorised Manufacturer of Serial Production – Production Sites (valid from: 2016-04-07):**

<b>Company</b>	P.F.B. s.r.l.
<b>Address</b>	Via Raimondo Dalla Costa, 690 41122 Modena – Italy

- END OF DOCUMENT -

Sez.A-A

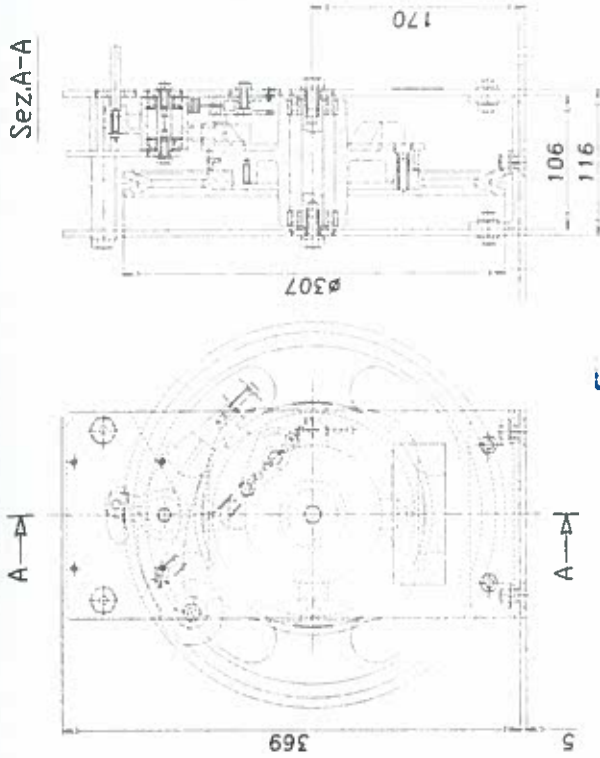

07. APR. 2016

**GEPRÜFT / APPROVED**  
 TÜV SÜD Industrie Service GmbH  
 Prüflaboratorium für Produkte der Erdertechnik  
 Westendstraße 99  
 80549 München  
 Sachverständigen(r) / Expert

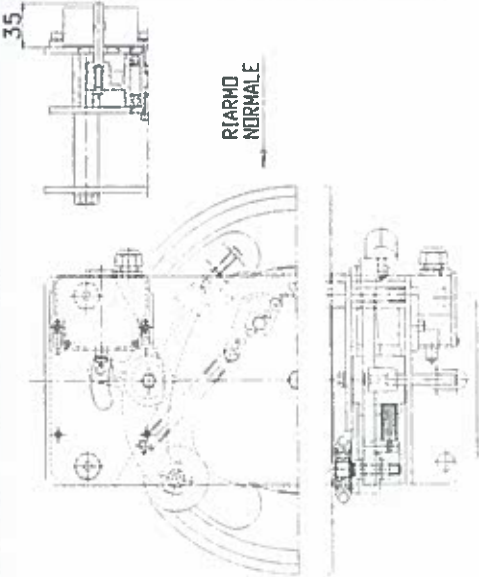
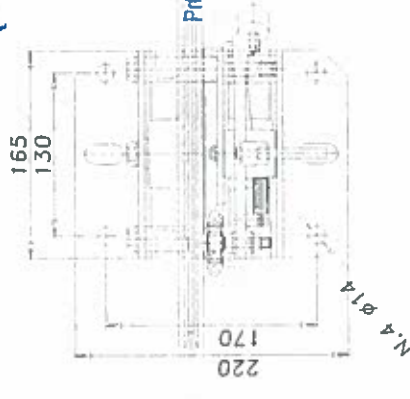

APPLICAZIONE  
 DISPOSITIVO  
 A3 CON LSE

RIARMO  
 NORMALE

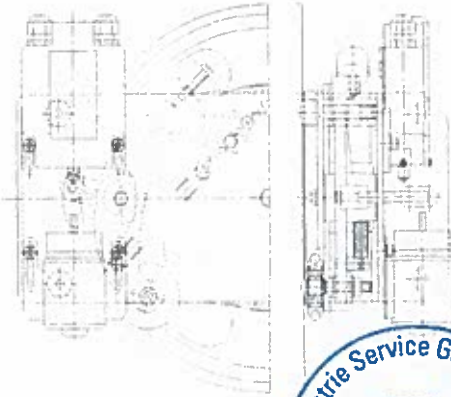

APPLICAZIONE  
 ELETTROMAGNETE  
 LSP

APPLICAZIONE  
 COMANDO  
 A DISTANZA



Spusci non quotati / 45°	scalo 1:4	q.to'	LAVORGEN.	NOTE
Raggi non quotati	DENOMINAZIONE		MATERIALE	
TOLLERANZE LIBERE	COMPLESSIVO		QUALITA'	
S.L. TRUCCO: TOLL.	GRUPPO LIMITATORE LK_300		STATO-N°-MOD.	
∇ ± 0,2	INTERNATIONAL APPLICATION N° PCT/EP97/00466		DIMEN.	
∇∇ ± 0,15	COMPONENTI MECCANICI		PESO kg.	
∇∇∇ ± 0,1	PER ASCENSORI		T.T.	
∇∇∇ ± 20°	P.F.B.		DIS.	VER.
∇∇∇ 0,04	IL PRESENTE DISEGNO E' DI PROPRIETA' DELLA PFB SRL, NE E' VIETATA LA DIVULGAZIONE A TERMINI DI LEGGE, SENZA AUTORIZZAZIONE		COD.N°	DATA
∇∇∇ 0,04	NFILC: LK_300_S.DWG		DIS.N°	12/'97
∇∇∇ 0,04	MODIFICHE - MODIFIKATIONEN			

NR	DATA	DESCRIZIONE
NR	DATUM	BESCHREIBUNG
5	22/06/'15	VERIFICATI TUTTI I DISEGNI (Studio re srt)
4	10/'11	AGGIUNTA VARIANTE CON ELETTROMAGNETE
3	10/'00	MODIFICATA PULEGGIA DI PROVA
2	06/'99	AGGIUNTO CONTRAPPESO PER SALTARELLI
1	02/'99	TUTTI I PZ SEEGER NEL MOZZO DELLA PULEGGIA

LK-200A/250A/300A/315A  
cod. 802420200/250/300/315



RIARMO NORMALE

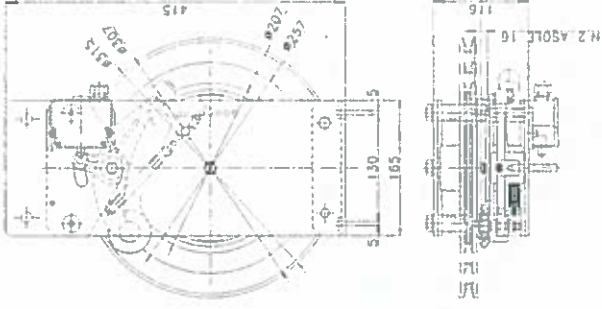

COMANDO A DISTANZA

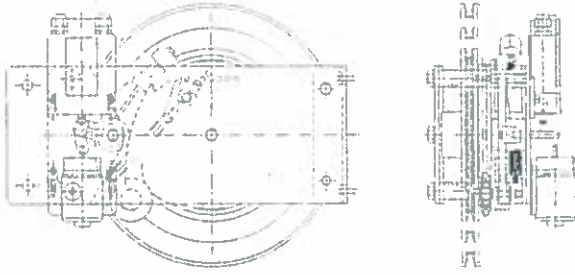

DISPOSITIVO A3 CON LSE

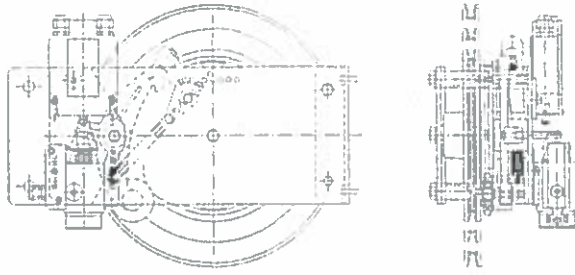

ELETTROMAGNETE LSP

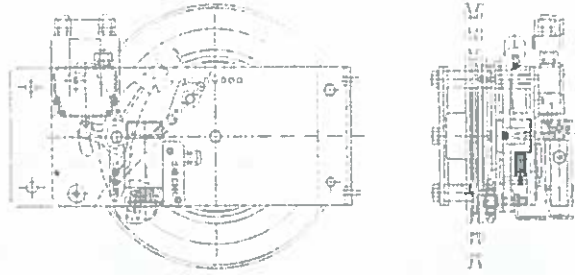

07. APR. 2016

**GEPRÜFT / APPROVED**  
TUV SUD Industrie Service GmbH  
Prüflaboratorium für Produkte der Elektrotechnik  
Westendstraße 199  
80688 München  
Sachverständige(D)/Expert

MODIFICHE - MODIFIKATIONEN

Rev.	Descr.	Aut.	Data
5			
4			
3			
2			
1			
0			

DESCRIZIONE	VALORI	UNITA'	NOTE
TURBIDITA'	1/4	litro	
DETERMINAZIONE			
CEPESIVO LIMIATURI LK TIPO APPESD			
200/250/300/315			
GRUPPO	LK-200A/250A/300A/315A		
INTERNATIONAL APPLICATION N°	PC7/EP97/DH66		
DATA	07/07/16		
VERSIONE	002420200 GEN		
DISP.	LK_A_DE		



L.K. A. DE