



MONTEFERRO

**PRODUCT
&
SERVICES**



Simply Up

MONTEFERRO is the complete market source for elevator guide rails solutions, in accordance with International and Customer specific standards. MONTEFERRO offers the widest range of cold drawn and machined guide rails, guide rails for high speed application and a complete line of components and accessories to form the integrated hoistway systems. Guide rails are vital for proper elevator ride comfort and safety. Their development represents a specific and unique product whose manufacturing technology and process results from years of study, research and industry experience. The high quality and superior performance of MONTEFERRO products are a testament to the company's continuous pursuit of manufacturing excellence.



Specifications

MONTEFERRO introduced cold drawn processing into the guide rail market at the end of the 40's. Through continuous improvements and optimization in co-operation with the rolling mill, today on the market is available a complete range of cold drawn guide rails from 3 Kg/mt to 14 Kg/mt.

Standard Cold Drawn Guide Rails

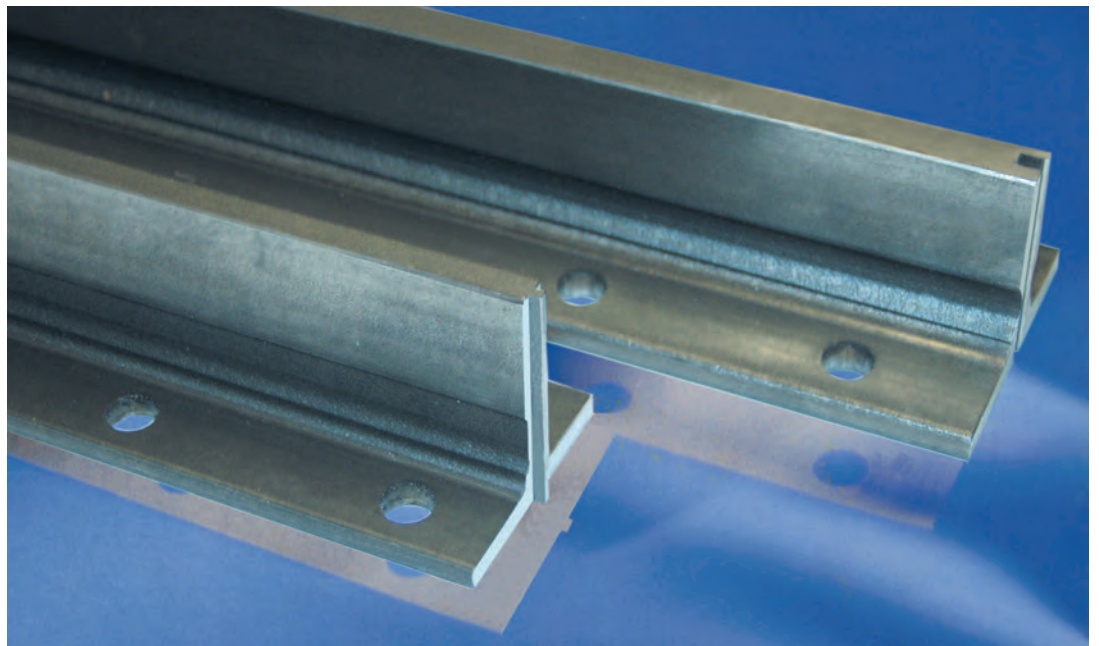

REFERENCE NORM: ISO 7465. RAW MATERIAL: E 235 B (ISO 630: 1995). GUIDE RAIL LENGTH: 5,000 MM \pm 2MM. DIFFERENT LENGTH ACCORDING TO CUSTOMER'S REQUIREMENTS DIFFERENT GUIDE RAILS SECTIONS AND SPECIFICATIONS: ACCORDING TO DEFINITION WITH CUSTOMERS.

DIMENSIONS

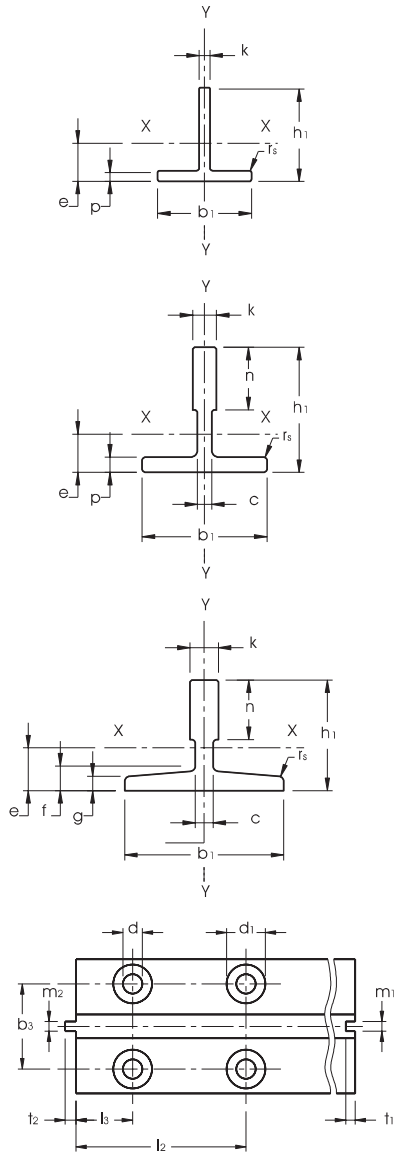

Monteferro Code	ISO Code	b_1 mm	h_1 mm	k mm	n mm
Tolerances		$\pm 0,5$	$\pm 0,2$	$\pm 0,15$	
RT 40	---	40	40	5	
RT 45	T 45/A	45	45	5	
RT 45 M/F	---	45	45	5	
RT 50	T 50/A	50	50	5	
RT 50 M/F	---	50	50	5	
Tolerances		$\pm 1,5$	$\pm 0,1$	$+0,1/0$	$+3/0$
RT 70	T 70-2/A	70	70	8	
RT 80	---	80	80	9	
Tolerances		$\pm 1,5$	$\pm 0,1$	$+0,1/0$	$+3/0$
RF 50	---	50	50	9	35
RF 70	T 70-1/A	70	65	9	34
RF 70.9	---	70	70	9	35
RF 75	T 75-3/A	75	62	10	30
Tolerances		$\pm 1,5$	$\pm 0,1$	$+0,1/0$	$+3/0$
RF 65	---	65	54	7,9	20
RF 82	T 82/A	82,5	68,25	9	25,4
RF 89	T 89/A	89	62	15,88	33,4
RF 90	T 90/A	90	75	16	42

KEY FACTORS

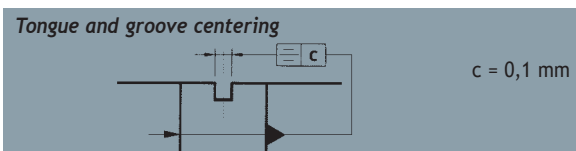
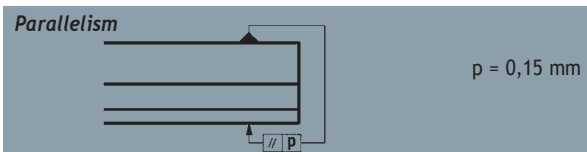
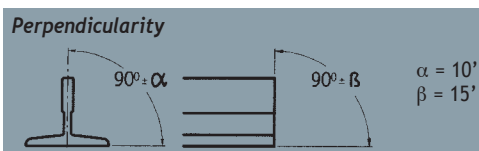
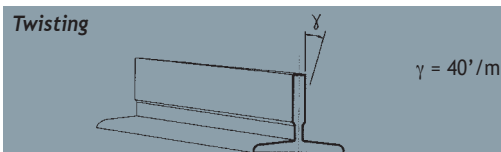
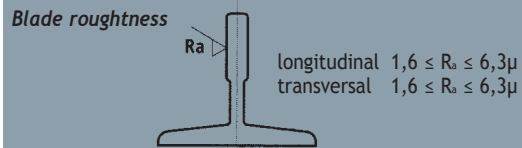

c mm	p mm	g mm	f mm	r _s mm	m ₁ mm	m ₂ mm	t ₁ mm	t ₂ mm	d mm	d _i mm	b ₁ mm	l ₂ mm	l ₃ mm
	±0,5				+0,06/-0	+0/-0,06	±0,1	±0,1			±0,2	±0,2	±0,2
	5			1	2	1,95	2,5	2	9		23	85	15
	5			1					9		25	65	15
	5			1	2	1,95	2,5	2	9		25	65	15
	5			1					9		30	75	25
	5			1	2	1,95	2,5	2	9		30	75	25
	±0,75				+0,06/-0	+0/-0,06	±0,1	±0,1			±0,2	±0,2	±0,2
	8			1,5	3	2,95	3,5	3	13		42	105	25
	9			1,5	3	2,95	3,5	3	13		42	105	25
		±0,75			+0,06/-0	+0/-0,06	±0,1	±0,1			±0,2	±0,2	±0,2
7,5	6,5			1	3	2,95	3,5	3	9		30	75	25
6	7			1,5	3	2,95	3,5	3	13		42	105	25
7,9	8,5			1,5	3	2,95	3,5	3	13		43	90	30
8	7,5			1,5	3	2,95	3,5	3	13		43	90	30
		±0,75	±0,75		+0,06/-0	+0/-0,06	±0,1	±0,1		*	±0,2	±0,2	±0,2
5		4	6	1,5	2	1,95	2,5	2	10	24*	40	65	15
7,5		6	8,25	3	3	2,95	3,5	3	13	26*	50,8	81	27
10		7,9	11,1	3	6,4	6,37	7,14	6,35	13	26*	57,2	114,3	38,1
10		8	10	4	6,4	6,37	7,14	6,35	13	26*	57,2	114,3	38,1

* on demand

TECHNICAL CHARACTERISTICS

Monteferro Code	ISO Code	S cm ²	q ₁ kg/m	e cm	I _{xx} cm ⁴	W _{xx} cm ³	i _{xx} cm	I _{yy} cm ⁴	W _{yy} cm ³	i _{yy} cm
RT40	---	3,7	2,95	1,18	5,52	1,95	1,21	2,67	1,33	0,84
RT45	T45/A	4,25	3,34	1,31	8,08	2,53	1,38	3,84	1,71	0,95
RT50	T50/A	4,75	3,73	1,43	11,24	3,15	1,54	5,25	2,1	1,05
RT70	T70-2/A	10,52	8,26	2,02	47,43	9,63	2,12	23,13	6,61	1,48
RT80	---	13,56	10,65	2,32	80,2	14,21	2,44	38,83	9,7	1,69
RF50	---	7,07	5,55	1,70	17,36	5,26	1,57	7,02	2,81	0,99
RF70	T70-1/A	9,51	7,47	2,04	41,3	9,24	2,09	18,65	5,35	1,40
RF70.9	---	11,25	8,83	2,11	52,81	10,79	2,16	24,62	7,03	1,48
RF75	T75-3/A	10,99	8,63	1,86	40,35	9,29	1,92	26,49	7,06	1,55
RF65	---	6,24	4,9	1,71	20,09	5,44	1,79	10,92	3,36	1,32
RF82	T82/A	10,9	8,55	1,98	49,4	10,2	2,13	30,5	7,4	1,67
RF89	T89/A	15,7	12,3	2,02	59,52	14,25	1,95	52,4	11,8	1,83
RF90	T90/A	17,25	13,55	2,61	102	20,87	2,43	52,6	11,8	1,75



Specifications

MONTEFERRO machined guiderail product range includes rails from 8 Kg/mt to 50 Kg/mt for usage in high load, high frequency, high speed and special applications. MONTEFERRO factories work towards a common standard, providing an enhanced riding surface.

Standard Machined Guide Rails

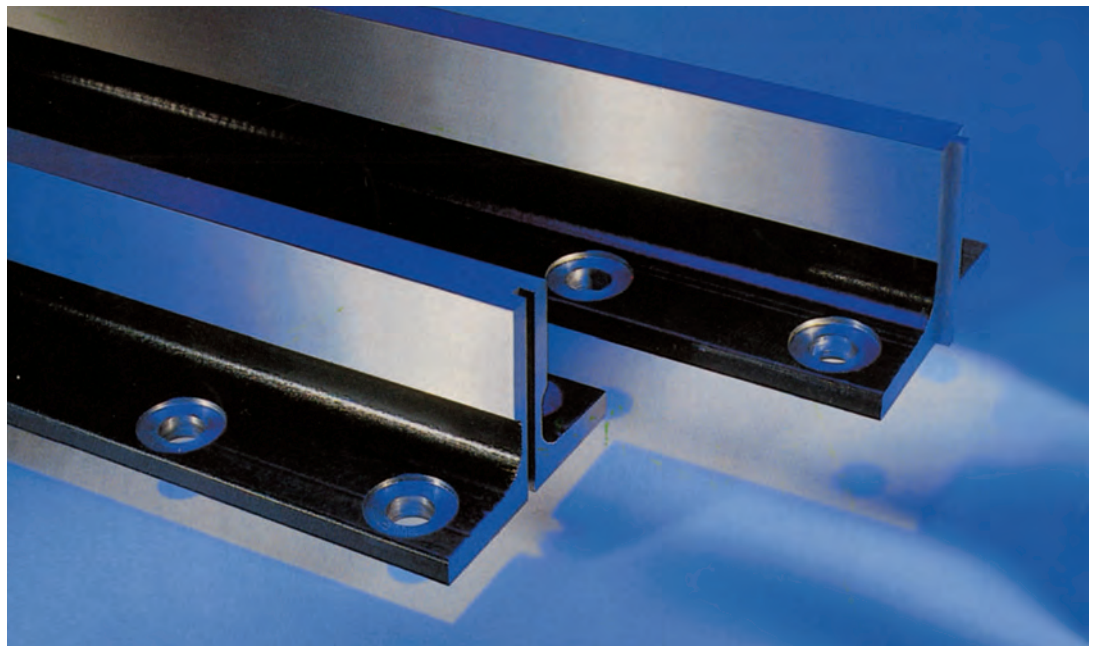

REFERENCE NORM: ISO 7465. RAW MATERIAL: E 275 B (ISO 630: 1995).

GUIDE RAIL LENGTH: 5,000 MM ± 2MM. DIFFERENT LENGTH ACCORDING TO CUSTOMER'S REQUIREMENTS

DIFFERENT GUIDE RAILS SECTIONS AND SPECIFICATIONS: ACCORDING TO DEFINITION WITH CUSTOMERS.

DIMENSIONS

Monteferro Code	ISO Code	b ₁ mm	h ₁ mm	h mm	k mm	n mm	c mm	g mm	f mm
RP 75	T 75-3/B	75	62	61	10	30	8	7	9
RP 78	---	78	56	55	10	26	7	6	8,5
RP 82	T 82/B	82,5	68,25	66,6	9	25,4	7,5	6	8,25
RP 89	T 89/B	89	62	61	15,88	33,4	10	7,9	11,1
RP 90	T 90/B	90	75	74	16	42	10	8	10
RP 114	---	114	88,9	88	15,88	38	9,5	7,9	11,1
RP 125	T 125/B	125	82	81	16	42	10	9	12
RP 127-1	T 127-1/B	127	88,9	88	15,88	44,5	10	7,9	11,1
RP 127-2	T 127-2/B	127	88,9	88	15,88	50,8	10	12,7	15,9
RP 127-2 c 14	---	127	88,9	88	15,88	50,8	14	12,7	15,9
RP 140-1	T 140-1/B	140	108	107	19	50,8	12,7	12,7	15,9
RP 140-2	T 140-2/B	140	102	101	28,6	50,8	17,5	14,5	17,5
RP 140-3	T 140-3/B	140	127	126	31,75	57,2	19	17,5	25,4

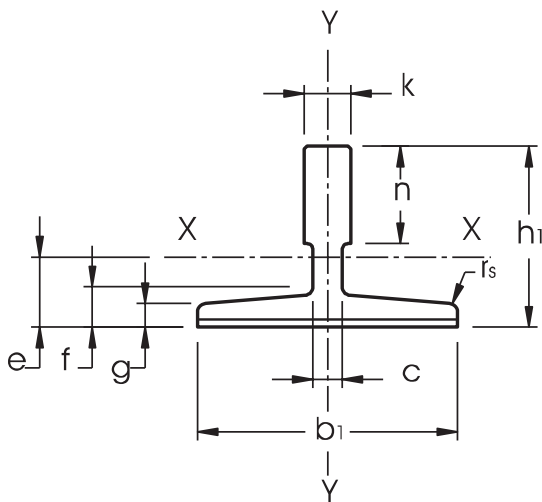

KEY FACTORS

Blade roughness

longitudinal $R_a \leq 1,6\mu$
transversal $1,6 \leq R_a \leq 3,2\mu$

Twisting

$\gamma = 30' / m$

Perpendicularity

$\alpha = 5'$
 $\beta = 15'$

Straightness

$B/A = 0,001$
 $B_{max} (5 m) = 1,5 mm$
 $B_{1m} = 0,3 mm$

Parallelism

$p = 0,1 mm$

Tongue and groove centering

$c = 0,1 mm$

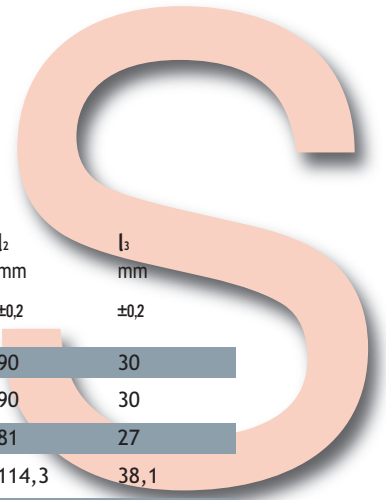

r_s mm	m_1 mm	m_2 mm	t_1 mm	t_2 mm	l mm	d mm	d_1 mm	b_3 mm	l_2 mm	l_3 mm
	+0,06/0	+0/-0,06	±0,1	±0,1	+3/0			±0,2	±0,2	±0,2
3	3	2,95	3,5	3	123	13	26	43	90	30
3	3	2,95	3,5	3	123	13	26	43	90	30
3	3	2,95	3,5	3	111	13	26	50,8	81	27
3	6,4	6,37	7,14	6,35	156	13	26	57,2	114,3	38,1
4	6,4	6,37	7,14	6,35	156	13	26	57,2	114,3	38,1
4	6,4	6,37	7,14	6,35	156	17	33	79,4	114,3	38,1
4	6,4	6,37	7,14	6,35	156	17	33	79,4	114,3	38,1
4	6,4	6,37	7,14	6,35	156	17	33	79,4	114,3	38,1
5	6,4	6,37	7,14	6,35	156	17	33	79,4	114,3	38,1
5	6,4	6,37	7,14	6,35	156	17	33	79,4	114,3	38,1
5	6,4	6,37	7,14	6,35	193	21	40	92,1	152,4	31,8
5	6,4	6,37	7,14	6,35	193	21	40	92,1	152,4	31,8
5	6,4	6,37	7,14	6,35	193	21	40	92,1	152,4	31,8

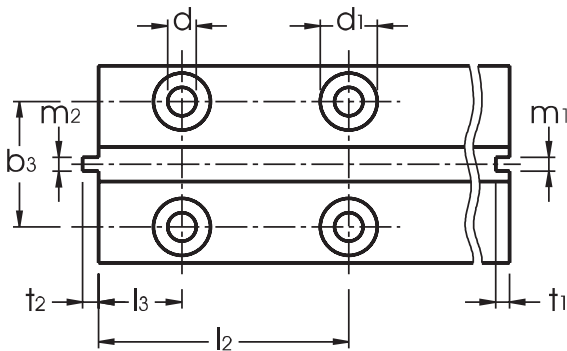

TECHNICAL CHARACTERISTICS

Monteferro Code	ISO Code	S cm ²	q ₁ kg/m	e cm	I _{xx} cm ⁴	W _{xx} cm ³	i _{xx} cm	I _{yy} cm ⁴	W _{yy} cm ³	i _{yy} cm
RP 75	T 75-3/B	10,99	8,63	1,86	40,35	9,29	1,92	26,49	7,06	1,55
RP 78	---	9,84	7,72	1,65	29,9	7,56	1,47	26,1	6,71	1,63
RP 82	T 82/B	10,9	8,55	1,98	49,4	10,2	2,13	30,5	7,4	1,67
RP 89	T 89/B	15,7	12,3	2,02	59,52	14,25	1,95	52,4	11,8	1,83
RP 90	T 90/B	17,25	13,55	2,61	102	20,87	2,43	52,6	11,8	1,75
RP 114	---	20,85	16,37	2,87	179	29,7	2,93	108	19,1	2,29
RP 125	T 125/B	22,83	17,9	2,43	151	26,2	2,57	159	25,4	2,64
RP 127-1	T 127-1/B	22,64	17,77	2,75	186,2	30,4	2,87	148	23,4	2,56
RP 127-2	T 127-2/B	28,63	22,48	2,47	198,4	30,9	2,63	230	36,2	2,83
RP 127-2c14	---	29,53	23,18	2,5	198,8	31,1	2,59	229,6	36,2	2,78
RP 140-1	T 140-1/B	35,2	27,6	3,24	404	53,4	3,39	310	44,3	2,97
RP 140-2	T 140-2/B	43,22	33,92	3,47	457	68	3,25	358	51,2	2,88
RP 140-3	T 140-3/B	58,57	46	4,38	953	114,6	4,03	486	69,4	2,88



Specifications

For all major sizes of machined guide rails according to ISO, JIS and other standards as well as for Customer specific standard, reduced tolerances and special requirements are offered based on ride comfort and elevator speed application.

High Quality Guide Rails

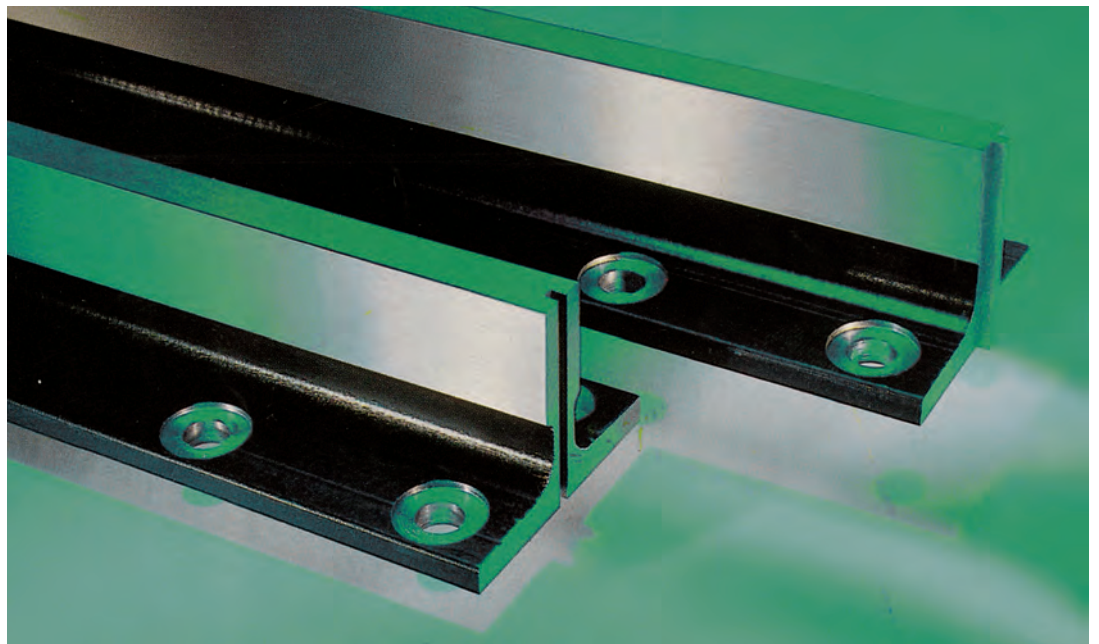

REFERENCE NORM: ISO 7465. RAW MATERIAL: E 275 B (ISO 630: 1995).

GUIDE RAIL LENGTH: 5,000 MM ± 2MM. DIFFERENT LENGTH ACCORDING TO CUSTOMER'S REQUIREMENTS

DIFFERENT GUIDE RAILS SECTIONS AND SPECIFICATIONS: ACCORDING TO DEFINITION WITH CUSTOMERS.

DIMENSIONS

Monteferro Code	ISO Code	b ₁ mm	h ₁ mm	h mm	k mm	n mm	c mm	g mm	f mm
Tolerances		±1,5	±0,75	±0,05	+0,05/-0	+3/0		±0,75	±0,75
RP 75 H	T 75-3/BE	75	62	61	10	30	8	7	9
RP 78 H	---	78	56	55	10	26	7	6	8,5
RP 82 H	T 82/BE	82,5	68,25	66,6	9	25,4	7,5	6	8,25
RP 89 H	T 89/BE	89	62	61	15,88	33,4	10	7,9	11,1
RP 90 H	T 90/BE	90	75	74	16	42	10	8	10
RP 114 H	---	114	88,9	88	15,88	38	9,5	7,9	11,1
RP 125 H	T 125/BE	125	82	81	16	42	10	9	12
RP 127-1 H	T 127-1/BE	127	88,9	88	15,88	44,5	10	7,9	11,1
RP 127-2 H	T 127-2/BE	127	88,9	88	15,88	50,8	10	12,7	15,9
RP 127-2 C 14H	---	127	88,9	88	15,88	50,8	14	12,7	15,9
RP 140-1 H	T 140-1/BE	140	108	107	19	50,8	12,7	12,7	15,9
RP 140-2 H	T 140-2/BE	140	102	101	28,6	50,8	17,5	14,5	17,5
RP 140-3 H	T 140-3/BE	140	127	126	31,75	57,2	19	17,5	25,4

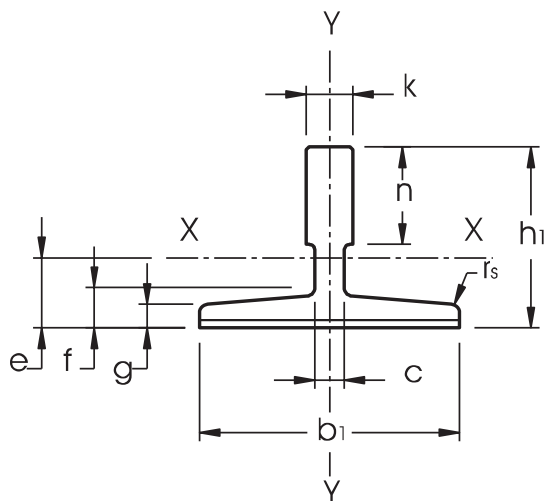

KEY FACTORS

Blade roughness

longitudinal $R_a \leq 1,6\mu$
transversal $1,6 \leq R_a \leq 2,5\mu$

Straightness

$B/A = 0,0004$
 $B_{max} (5 m) = 1 mm$
 $B_{min} = 0,2 mm$

Twisting

$\gamma = 15' / m$

Parallelism

$p = 0,05 mm$

Perpendicularity

$\alpha = 5'$
 $\beta = 12'$

Tongue and groove centering

$c = 0,05 mm$

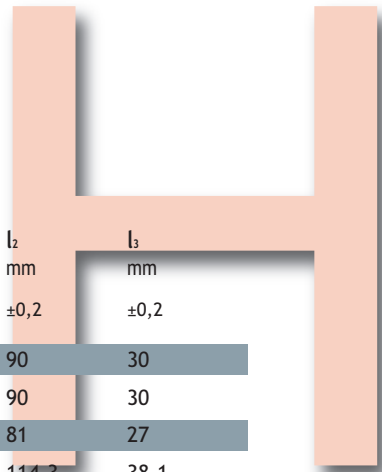

r_s mm	m_1 mm +0,03/-0	m_2 mm +0/-0,03	t_1 mm $\pm 0,1$	t_2 mm $\pm 0,1$	l mm +3/0	d mm	d_1 mm	b_3 mm $\pm 0,2$	l_2 mm $\pm 0,2$	l_3 mm $\pm 0,2$
3	3	2,95	3,5	3	123	13	26	43	90	30
3	3	2,95	3,5	3	123	13	26	43	90	30
3	3	2,95	3,5	3	111	13	26	50,8	81	27
3	6,4	6,37	7,14	6,35	156	13	26	57,2	114,3	38,1
4	6,4	6,37	7,14	6,35	156	13	26	57,2	114,3	38,1
4	6,4	6,37	7,14	6,35	156	17	33	79,4	114,3	38,1
4	6,4	6,37	7,14	6,35	156	17	33	79,4	114,3	38,1
4	6,4	6,37	7,14	6,35	156	17	33	79,4	114,3	38,1
5	6,4	6,37	7,14	6,35	156	17	33	79,4	114,3	38,1
5	6,4	6,37	7,14	6,35	156	17	33	79,4	114,3	38,1
5	6,4	6,37	7,14	6,35	193	21	40	92,1	152,4	31,8
5	6,4	6,37	7,14	6,35	193	21	40	92,1	152,4	31,8
5	6,4	6,37	7,14	6,35	193	21	40	92,1	152,4	31,8

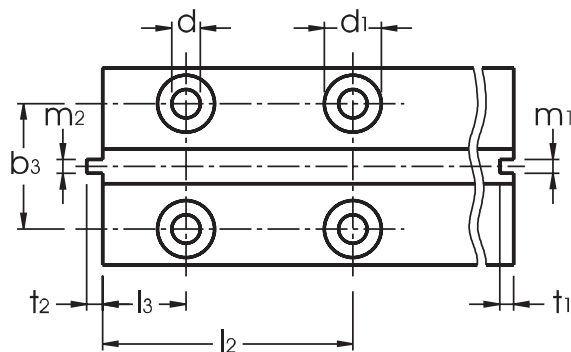

TECHNICAL CHARACTERISTICS

Monteferro Code	ISO Code	S cm ²	q ₁ kg/m	e cm	I _{xx} cm ⁴	W _{xx} cm ³	i _{xx} cm	I _{yy} cm ⁴	W _{yy} cm ³	i _{yy} cm
RP 75 H	T 75-3/BE	10,99	8,63	1,86	40,35	9,29	1,92	26,49	7,06	1,55
RP 78 H	---	9,84	7,72	1,65	29,9	7,56	1,47	26,1	6,71	1,63
RP 82 H	T 82/BE	10,9	8,55	1,98	49,4	10,2	2,13	30,5	7,4	1,67
RP 89 H	T 89/BE	15,7	12,3	2,02	59,52	14,25	1,95	52,4	11,8	1,83
RP 90 H	T 90/BE	17,25	13,55	2,61	102	20,87	2,43	52,6	11,8	1,75
RP 114 H	---	20,85	16,37	2,87	179	29,7	2,93	108	19,1	2,29
RP 125 H	T 125/BE	22,83	17,9	2,43	151	26,2	2,57	159	25,4	2,64
RP 127-1H	T 127-1/BE	22,64	17,77	2,75	186,2	30,4	2,87	148	23,4	2,56
RP 127-2H	T 127-2/BE	28,63	22,48	2,47	198,4	30,9	2,63	230	36,2	2,83
RP 127-2c14H	---	29,53	23,18	2,5	198,8	31,1	2,59	229,6	36,2	2,78
RP 140-1H	T 140-1/BE	35,2	27,6	3,24	404	53,4	3,39	310	44,3	2,97
RP 140-2H	T 140-2/BE	43,22	33,92	3,47	457	68	3,25	358	51,2	2,88
RP 140-3H	T 140-3/BE	58,57	46	4,38	953	114,6	4,03	486	69,4	2,88



Specifications

MONTEFERRO Match guide rails have set a standard for the highest speed elevator market segment.

Match Guide Rails

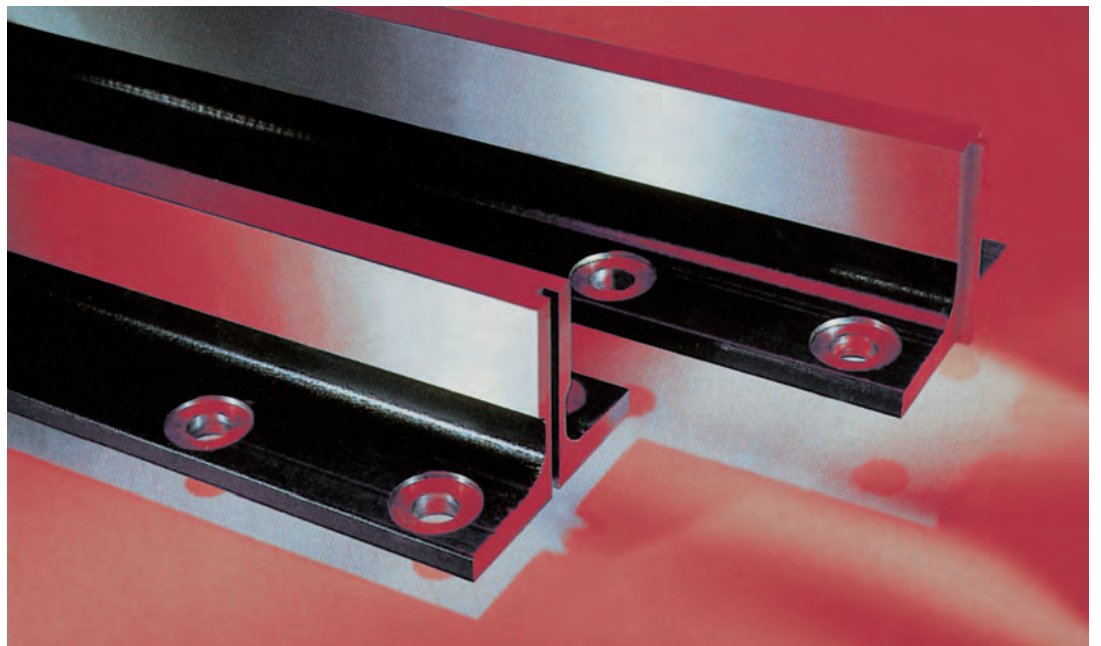

RAW MATERIAL: E 275 B (ISO 630: 1995).

GUIDE RAIL LENGTH: 5,000 MM ± 2MM. DIFFERENT LENGTH ACCORDING TO CUSTOMER'S REQUIREMENTS

DIFFERENT GUIDE RAILS SECTIONS AND SPECIFICATIONS: ACCORDING TO DEFINITION WITH CUSTOMERS.

DIMENSIONS

Monteferro Code	ISO Code	b ₁ mm	h ₁ mm	h mm	k mm	n mm	c mm	g mm	f mm
Tolerances		±1,5	±0,75	±0,03	+0,05/-0	+3/0		±0,75	±0,75
RP 75 M	---	75	62	61	10	30	8	7	9
RP 78 M	---	78	56	55	10	26	7	6	8,5
RP 82 M	---	82,5	68,25	66,6	9	25,4	7,5	6	8,25
RP 89 M	---	89	62	61	15,88	33,4	10	7,9	11,1
RP 90 M	---	90	75	74	16	42	10	8	10
RP 114 M	---	114	88,9	88	15,88	38	9,5	7,9	11,1
RP 125 M	---	125	82	81	16	42	10	9	12
RP 127-1M	---	127	88,9	88	15,88	44,5	10	7,9	11,1
RP 127-2M	---	127	88,9	88	15,88	50,8	10	12,7	15,9
RP 127-2c 14M	---	127	88,9	88	15,88	50,8	14	12,7	15,9
RP 140-1M	---	140	108	107	19	50,8	12,7	12,7	15,9
RP 140-2M	---	140	102	101	28,6	50,8	17,5	14,5	17,5
RP 140-3M	---	140	127	126	31,75	57,2	19	17,5	25,4

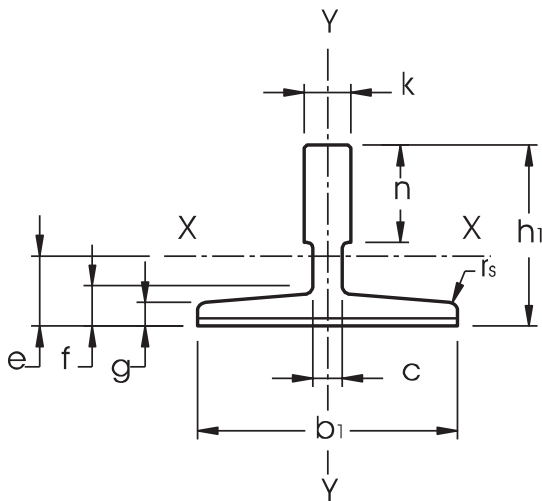

KEY FACTORS

Blade roughness

longitudinal $R_a \leq 1\mu$
transversal $1,6 \leq R_a \leq 2,5\mu$

Twisting

$\gamma = 15' / m$

Perpendicularity

$90^\circ \pm \alpha$
 $90^\circ \pm \beta$
 $\alpha = 5'$
 $\beta = 10'$

Straightness

$B/A = 0,0003$
 $B_{max} (5 m) = 0,5 mm$
 $B_{im} = 0,2 mm$

Parallelism

$p = 0,05 mm$

Tongue and groove centering

$c = 0,03 mm$

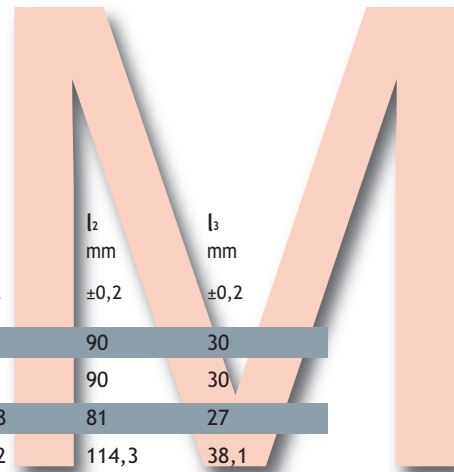

r_s mm	m_1 mm	m_2 mm	t_1 mm	t_2 mm	l mm	d mm	d_1 mm	b_3 mm	l_2 mm	l_3 mm
	+0,02/-0	+0/-0,02	±0,10	±0,10	+3/0			±0,2	±0,2	±0,2
3	3	2,95	3,5	3	123	13	26	43	90	30
3	3	2,95	3,5	3	123	13	26	43	90	30
3	3	2,95	3,5	3	111	13	26	50,8	81	27
3	6,4	6,37	7,14	6,35	156	13	26	57,2	114,3	38,1
4	6,4	6,37	7,14	6,35	156	13	26	57,2	114,3	38,1
4	6,4	6,37	7,14	6,35	156	17	33	79,4	114,3	38,1
4	6,4	6,37	7,14	6,35	156	17	33	79,4	114,3	38,1
4	6,4	6,37	7,14	6,35	156	17	33	79,4	114,3	38,1
5	6,4	6,37	7,14	6,35	156	17	33	79,4	114,3	38,1
5	6,4	6,37	7,14	6,35	156	17	33	79,4	114,3	38,1
5	6,4	6,37	7,14	6,35	193	21	40	92,1	152,4	31,8
5	6,4	6,37	7,14	6,35	193	21	40	92,1	152,4	31,8
5	6,4	6,37	7,14	6,35	193	21	40	92,1	152,4	31,8

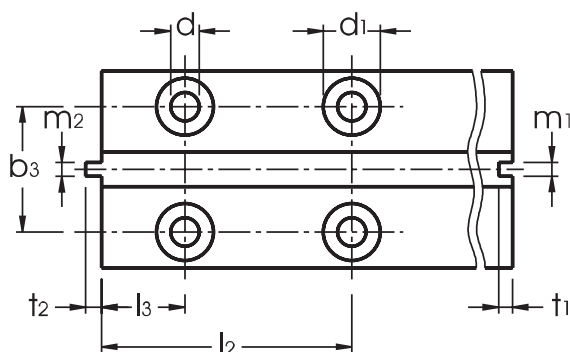

TECHNICAL CHARACTERISTICS

Monteferro Code	ISO Code	S cm ²	q ₁ kg/m	e cm	I _{xx} cm ⁴	W _{xx} cm ³	i _{xx} cm	I _{yy} cm ⁴	W _{yy} cm ³	i _{yy} cm
RP 75 M	---	10,99	8,63	1,86	40,35	9,29	1,92	26,49	7,06	1,55
RP 78 M	---	9,84	7,72	1,65	29,9	7,56	1,47	26,1	6,71	1,63
RP 82 M	---	10,9	8,55	1,98	49,4	10,2	2,13	30,5	7,4	1,67
RP 89 M	---	15,7	12,3	2,02	59,52	14,25	1,95	52,4	11,8	1,83
RP 90 M	---	17,25	13,55	2,61	102	20,87	2,43	52,6	11,8	1,75
RP 114 M	---	20,85	16,37	2,87	179	29,7	2,93	108	19,1	2,29
RP 125 M	---	22,83	17,9	2,43	151	26,2	2,57	159	25,4	2,64
RP 127-1 M	---	22,64	17,77	2,75	186,2	30,4	2,87	148	23,4	2,56
RP 127-2 M	---	28,63	22,48	2,47	198,4	30,9	2,63	230	36,2	2,83
RP 127-2c14 M	---	29,53	23,18	2,5	198,8	31,1	2,59	229,6	36,2	2,78
RP 140-1 M	---	35,2	27,6	3,24	404	53,4	3,39	310	44,3	2,97
RP 140-2 M	---	43,22	33,92	3,47	457	68	3,25	358	51,2	2,88
RP 140-3 M	---	58,57	46	4,38	953	114,6	4,03	486	69,4	2,88



Specifications

Fishplates are supplied in accordance with International and Customer specific standards. Special application fishplates such as Extra Thick, T-Plates, Minimum Clearance Seismic Plates (in accordance to ASME A17.1 for earthquake zone requirements) and the Ultra System are supplied to enhance joint performances on high speed application in conjunction with High Quality and Match guide rails. Clips including forged clips, sliding clips and special fastening systems as well as guide rail fixing systems, are supplied according to the various global code and Customer requirements.

Accessories

Fishplates

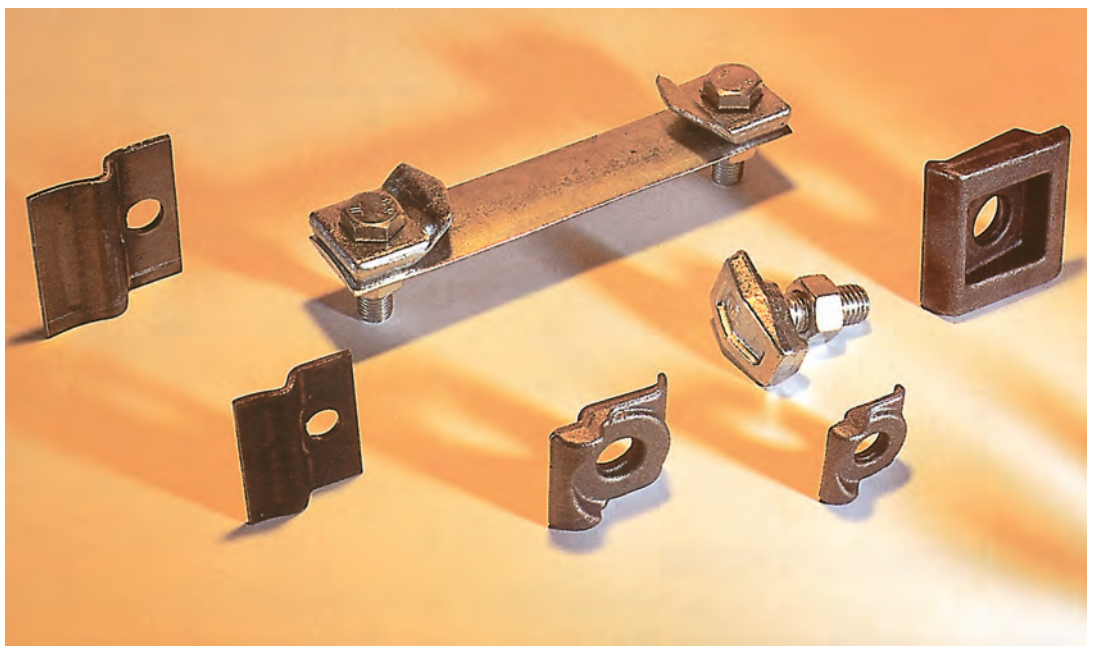
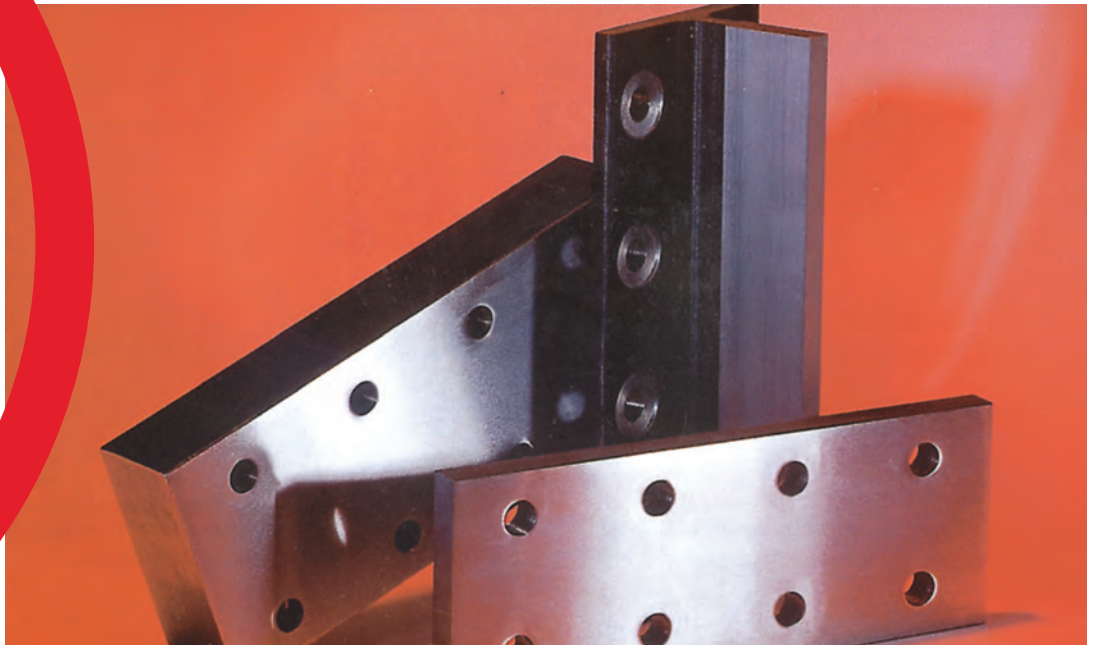

Clips

MONTEFERRO FISHPLATE RANGE ALSO INCLUDE:

THREADED (TAPPED) FISHPLATES, MINIMUM CLEARANCES SEISMIC FISHPLATE, SPECIAL FISHPLATE FOR HIGH SPEED APPLICATION.

COLD DRAWN GUIDE RAIL FISHPLATES

Monteferro Code	d mm	b ₂ mm	b ₃ mm	l ₁ mm	l ₂ mm	l ₃ mm	v mm	w _{xx} cm ³	w _{yy} cm ³	weight kg/pcs	bolt size
Tolerances		±1,5	±0,2	±1,5	±0,2	±0,2	0/+2				
RT40	9	40	23	200	85	15	6	1,60	0,24	0,35	M 8x25
RT45	9	50	25	160	65	15	8	3,33	0,53	0,50	M 8x25
RT50	9	50	30	200	75	25	8	3,33	0,53	0,60	M 8x25
RT70	13	70	42	250	105	25	10	8,17	1,17	1,29	M 12x35
RT80	13	80	42	250	105	25	10	10,67	1,33	1,49	M 12x35
RF50	9	50	30	200	75	25	8	3,33	0,53	0,60	M 8x25
RF65	10	70	40	160	65	15	10	8,17	1,17	0,83	M 10x30
RF70	13	70	42	250	105	25	10	8,17	1,17	1,29	M 12x35
RF70-9	13	75	43	240	90	30	10	9,38	1,25	1,33	M 12x35
RF75	13	75	43	240	90	30	10	9,38	1,25	1,33	M 12x35
RF82	13	80	50,8	216	81	27	10	10,67	1,33	1,27	M 12x35
RF89	13	90	57,2	305	114,3	38,1	10	13,50	1,50	2,07	M 12x35
RF90	13	90	57,2	305	114,3	38,1	10	13,50	1,50	2,07	M 12x35

p = 0,2 mm

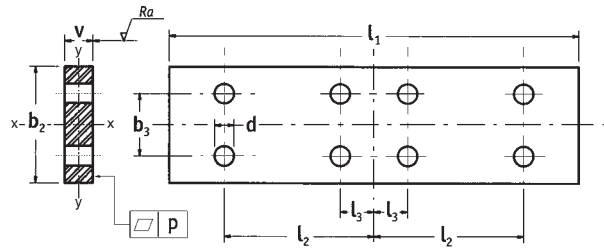

MACHINED GUIDE RAIL FISHPLATES

Monteferro Code	d mm	b ₂ mm	b ₃ mm	l ₁ mm	l ₂ mm	l ₃ mm	v mm	w _{xx} cm ³	w _{yy} cm ³	weight kg/pc	bolt size
Tolerances		±1,5	±0,2	±1,5	±0,2	±0,2	0/+3				
RP75	13	75	43	240	90	30	10	9,38	1,25	1,33	M 12x35
RP78	13	75	43	240	90	30	10	9,38	1,25	1,33	M 12x35
RP82	13	80	50,8	216	81	27	10	10,67	1,33	1,27	M 12x35
RP89	13	90	57,2	305	114,3	38,1	13	17,55	2,54	2,70	M 12x35
RP90	13	90	57,2	305	114,3	38,1	13	17,55	2,54	2,70	M 12x35
RP114	17	130	79,4	305	114,3	38,1	17/18	47,88	6,26	5,00	M 16x50
RP125	17	130	79,4	305	114,3	38,1	17/18	47,88	6,26	5,00	M 16x50
RP127-1	17	130	79,4	305	114,3	38,1	17/18	47,88	6,26	5,00	M 16x50
RP127-2	17	130	79,4	305	114,3	38,1	17/18	47,88	6,26	5,00	M 16x50
RP 127-2 c 14	17	130	79,4	305	114,3	38,1	17/18	47,88	6,26	5,00	M 16x50
RP140-1	21	140	92,1	380	152,4	31,8	25	81,67	14,58	11,00	M 20x65
RP140-2	21	140	92,1	380	152,4	31,8	25	81,67	14,58	11,00	M 20x65
RP140-3	21	140	92,1	380	152,4	31,8	30	98,00	21,00	13,20	M 20x80



p = 0,2 mm

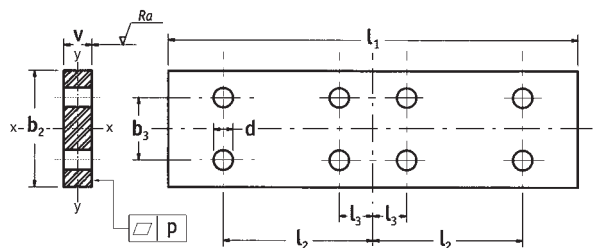

SPECIAL THICKNESS FISHPLATES

Monteferro Code	d mm	b ₂ mm	b ₃ mm	l ₁ mm	l ₂ mm	l ₃ mm	v * mm	w _{xx} cm ³	w _{yy} cm ³	weight kg/pc	bolt size
Tolerances		±1,5	±0,2	±1,5	±0,2	±0,2	0/+2				
RP75	13	75	43	240	90	30	12	11,25	1,80	1,60	M 12x35
RP78	13	75	43	240	90	30	12	11,25	1,80	1,60	M 12x35
RP82	13	80	50,8	216	81	27	20	21,33	5,33	2,55	M 12x45
RP89	13	90	57,2	305	114,3	38,1	20 30	27,00 40,50	6,00 13,50	4,14 6,21	M 12x45 M 12x55
RP90	13	90	57,2	305	114,3	38,1	20 30	27,00 40,50	6,00 13,50	4,14 6,21	M 12x45 M 12x55
RP114	17	130	79,4	305	114,3	38,1	30 40 50	84,50 112,67 140,83	19,50 34,67 54,17	8,91 11,88 14,85	M 16x60 M 16x70 M 16x80
RP125	17	130	79,4	305	114,3	38,1	30 35 40 50	84,50 98,58 112,67 140,83	19,50 26,54 34,67 54,17	8,91 10,40 11,88 14,85	M 16x60 M 16x70 M 16x70 M 16x80
RP127	17	130	79,4	305	114,3	38,1	30 35 40 50	84,50 98,58 112,67 140,83	19,50 26,54 34,67 54,17	8,91 10,40 11,88 14,85	M 16x60 M 16x70 M 16x70 M 16x80
RP140	21	140	92,1	380	152,4	31,8	40 50 75	130,67 163,33 245,00	37,33 58,33 131,25	15,84 19,79 29,69	M 20x90 M 20x100 M 20x120

*Other thickness under request

$$\frac{3.2}{\nabla} \leq \frac{Ra}{\nabla} \leq \frac{6.3}{\nabla}$$

p = 0,1 mm

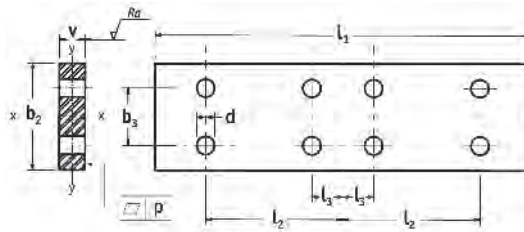

T SECTION FISHPLATES

Monteferro Code	d mm	d ₁ mm	b ₂ mm	b ₃ mm	l ₁ mm	l ₂ mm	l ₃ mm	h mm	w _{xx} cm ³	w _{yy} cm ³	weight kg/pc	bolt size
Tolerances			±1,5	±0,2	±1,5	±0,2	±0,2	±0,1				
RP75	13	26	75	43	240	90	30	61	9,29	7,06	2,1	M 12x35
RP78	13	26	78	43	240	90	30	55	7,56	6,71	1,8	M 12x35
RP82	13	26	82,5	50,8	216	81	27	66,6	10,2	7,40	1,36	M 12x35
RP89	13	26	89	57,2	305	114,3	38,1	61	14,25	11,80	3,8	M 12x35
RP90	13	26	90	57,2	305	114,3	38,1	74	20,87	11,80	4,1	M 12x35
RP114	17	33	114	79,4	305	114,3	38,1	88	29,70	19,10	5,0	M 16x50
RP125	17	33	125	79,4	305	114,3	38,1	81	26,20	25,40	5,5	M 16x50
RP127-1	17	33	127	79,4	305	114,3	38,1	88	30,40	23,40	5,4	M 16x50
RP127-2	17	33	127	79,4	305	114,3	38,1	88	30,90	36,20	6,9	M 16x50
RP127-2 c 14	17	33	127	79,4	305	114,3	38,1	88	31,06	36,25	7,0	M 16x50
RP140-1	21	40	140	92,1	380	152,4	31,8	107	53,40	44,30	10,5	M 20x65
RP140-2	21	40	140	92,1	380	152,4	31,8	101	68,00	51,20	12,9	M 20x65
RP140-3	21	40	140	92,1	380	152,4	31,8	126	114,60	69,40	17,5	M 20x65

$$\frac{3.2}{\nabla} \leq \frac{Ra}{\nabla} \leq \frac{6.3}{\nabla}$$

p = 0,1 mm

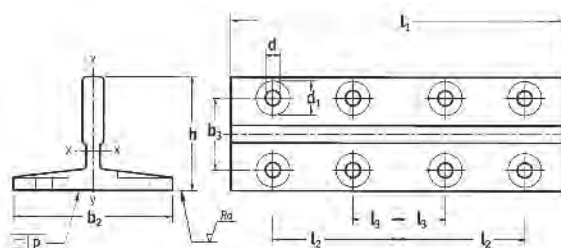

DIFFERENT GUIDE RAILS CLIPS: ACCORDING TO DEFINITION WITH CUSTOMER

T-CLIPS

Hot forged rigid guide rail clamping system. Recommended for application where guide rail stack movement is not expected. These clips come complete with threaded shank and nut. T-Clips are available both in burnished and zinc-coated finishing.

Monteferro Code	Applicable Guide Rail Size	Ø mm	A mm	B mm	C mm	D mm	E mm	F mm	G mm	H mm	S mm
Tolerances											
			±1,3	±1,3	+1,5/0	±1	±1	±0,5	±1	±1,3	±2
T1	RT40 RT45 RT50 - RF50 RF65	M10	32	22	15	12	5,5	5	11	23	50 55 60 75
T2	RT70 - RF70 - RF70.9 RF75 - RP75 RF82 - RP82	M12	39	26	16	15	7,3	6,5	13	27	83 88 95
T3	RT80 RP78 RF89 - RP89 RF90 - RP90	M14	45	29	16	18,5	9,5	8	13	34	96 94 105 106
T4	RP114 RP125 RP127-1	M16	50	34	16	20,5	10,5	8,5	15	40	131 142 144
T5	RP127-2 - RP127-2 c14 RP140-1 - RP140-2	M18	55	37	18	23	13	11	17	42	149 162

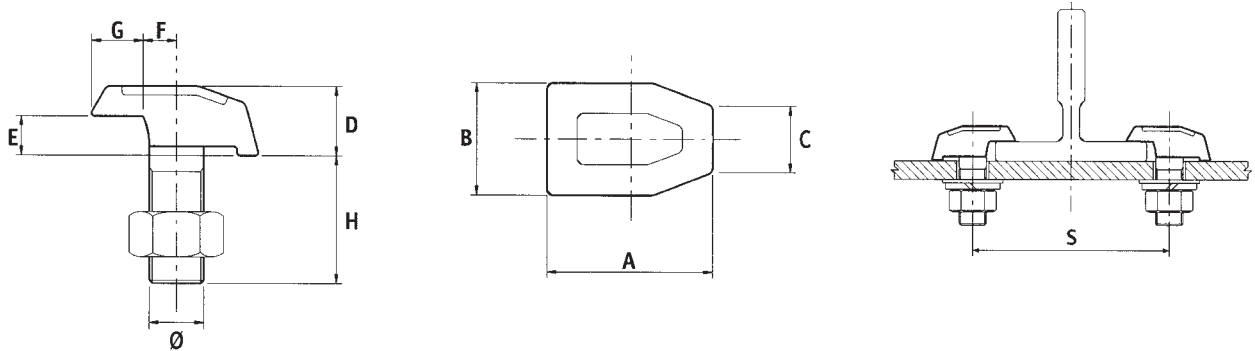

SLIDING CLIPS

Pressed steel sliding guide rail clamping system. Recommended for application where guide rail stack movement is required due to thermal expansion or building settlement.

Monteferro Code	Applicable Guide Rail Size	Ø mm	A mm	B mm	C mm	D mm	E mm	F mm	G mm	S mm	Bolt size
Tolerances											
		±0,5	±0,5	±0,5	±0,5	±0,1	±0,5	±0,5	±0,5	±2	
SL - P01	T45/A T50/A T65/A	9	45	32	14	3	2	7	11	67 72 87	M8x25
SL - P03	T70-1/A - T70-2/A T75-3/A & B T78 /B T82/A & B	13	76	60	31	4	4	14,5	18,5	107 112 115 120	M12x35
SL - P05	RF70.9 T80/A T89/A & B T90/A & B	13	76	60	31	4	6,5	14,5	18,5	107 117 126 127	M12x35
SL - P10	T114 B T125/B T127-1/B	13	76	70	31	5	7	16,5	18,5	151 162 164	M12x35
SL - P20	RP127-2 RP127-2 c14 RP140-1	17,5	76	70	33	5	12	20,5	19	166 178	M16x50
SL - P30	T140-2/B	19	88	82	46	5	12,5	20,5	25	190	M18x50
SL - P40	T140-3/B	19	88	82	46	6	14	20,5	25	190	M18x50

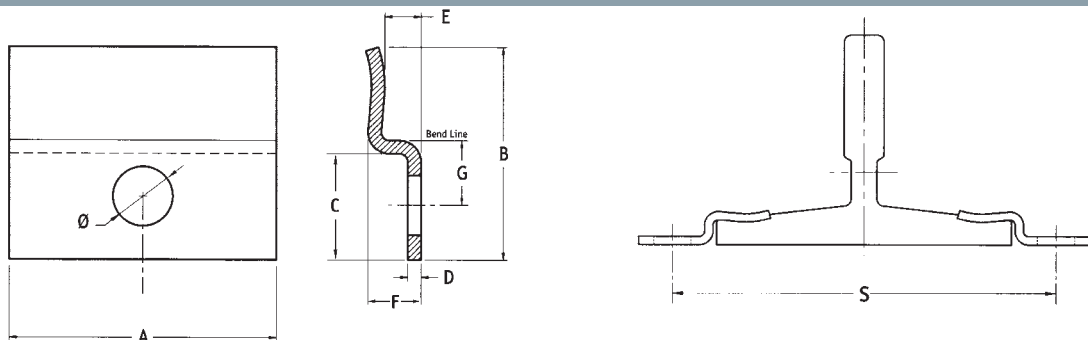

SLIDING CLAMPS

Hot forged sliding guide rail clamping system. Engineered to provide a point bearing contact used in conjunction with the Feather Edge radius guide rail seat. This clamp system provides the strength of a forged clip with the flexibility of the sliding clip.

Monteferro Code	Applicable Guide Rail Size	A mm	B mm	C mm	D mm	E mm	F mm	G mm	H mm	T mm	L mm	W mm	Ø mm	Bolt size
SL-F 10	RT50 - RF50	44	40	29	33	14	14	8	18	7	129	95	17	M12x45
SL-F 20	RT70 - RF70 - RF70.9	44	40	29	33	14	14	8	18	7	151	117	17	M12x45
SL-F 30	RF75 - RP75 - RP78	44	40	29	33	14	14	8	18	7	156	122	17	M12x45
SL-F 40	RF89 - RP89 - RF90 - RP90	44	40	29	33	14	14	8	18	7	172	138	17	M12x45
SL-F 45	RP125 - RP127-1	55	45	35	38	18	20	9	18	10	218	174	21	M16x50
SL-F 50	RP127-2 - RP127-2 C14	55	45	35	38	18	20	9	18	10	227	183	21	M16x50
SL-F 60	RP140-1	55	45	35	38	18	20	9	18	10	242	198	21	M16x50
SL-F 70	RP140-2	55	45	35	38	18	20	9	18	10	250	203	21	M16x50

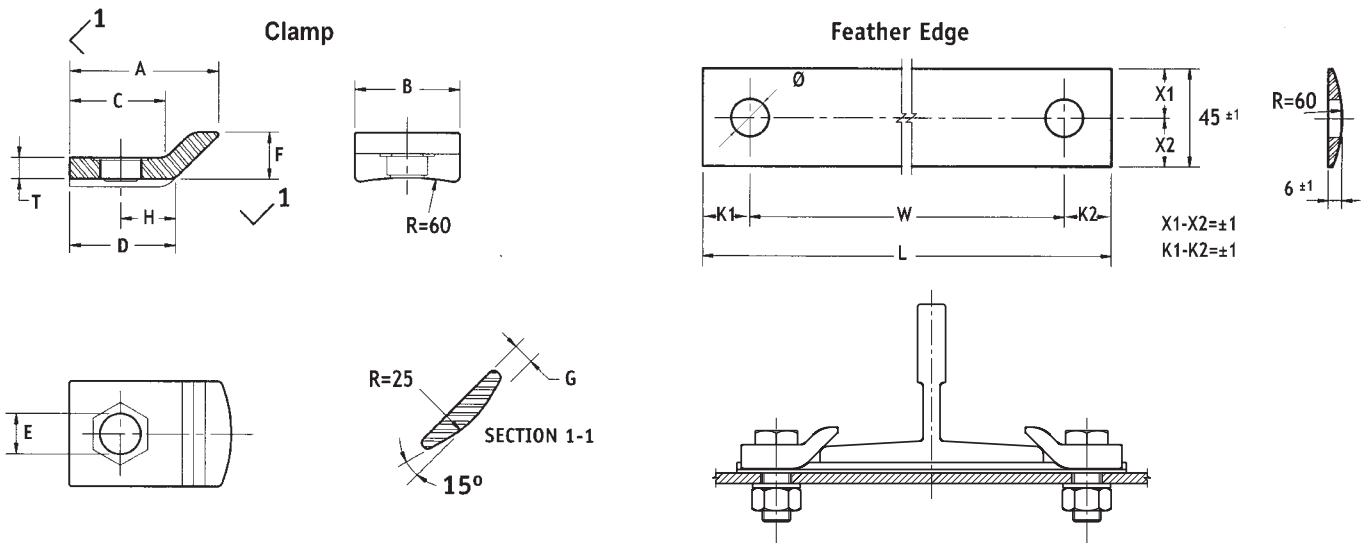

FORGED CLIPS

Hot forged rigid guide rail clamping system. Recommended for application where guide rail stack movement is not expected.

Monteferro Code	Applicable Guide Rail Size	A mm	B mm	C mm	D mm	E mm	F mm	G mm	M mm	Ø mm	S mm	Bolt size
F 10	RF89 - RP89 - RF90 - RP90	41	22	19	41	10	18	8	12,5	14,5	115	M12x45
F 20	RP114	55,5	30	25,5	51	16	25,5	12,5	17,5	17,5	150	M16x50
	162											
	164											
F 30	RP140-1	70	38	32	65	16	25,5	12,5	24	20,5	175	M18x50
	188											
F 40	RP140-3	70	38	32	76	19	28,5	19	24	20,5	188	M18x50

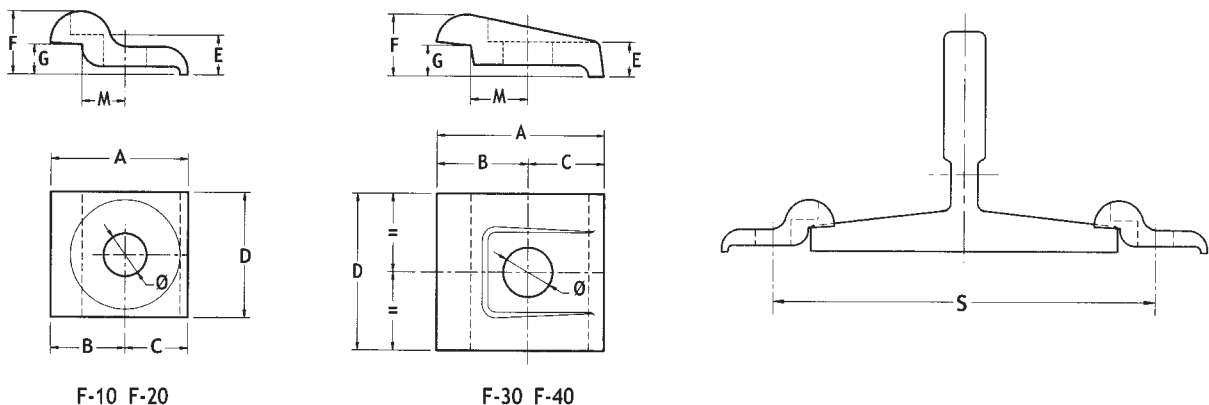



l n f o r

Each MONTEFERRO Customer has its own production, delivery and installation standards. By partnering with elevator companies, understanding their needs and suggesting solutions for improvements, MONTEFERRO has developed a wide range of recommendations for guide rail and accessory supply.

m a t i o n

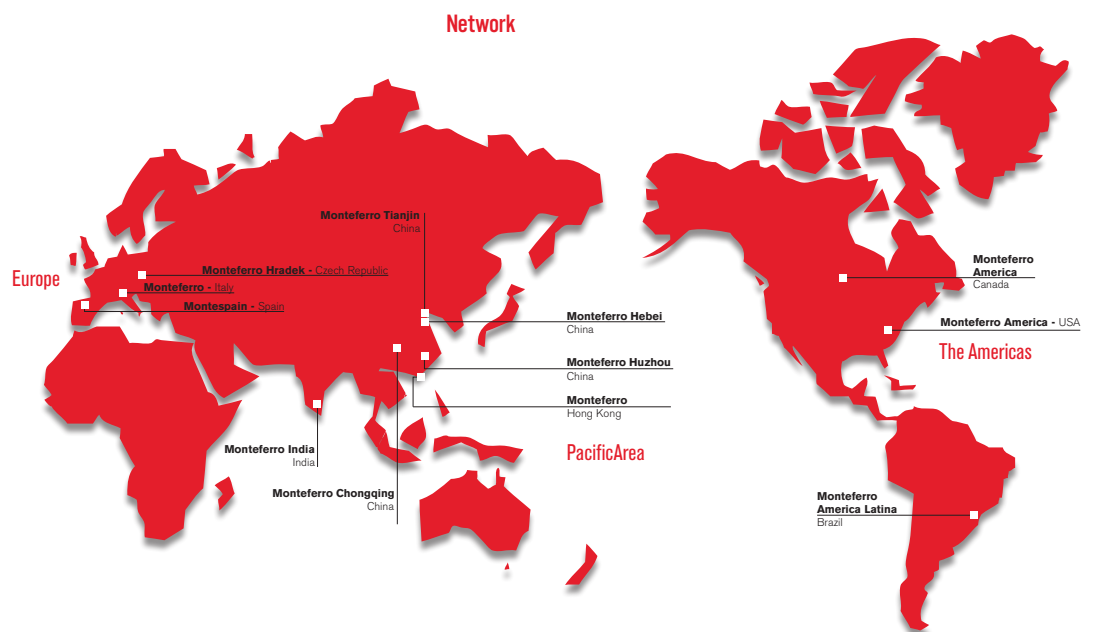

BUSINESS RELATIONS BETWEEN ELEVATOR COMPANIES AND THEIR SUPPLIERS HAVE CHANGED AND BECOME CLOSER AND CLOSER, TRANSFORMING SUPPLIERS INTO PARTNERS TO WHOM ADDITIONAL FUNCTIONS ARE DELEGATE. MONTEFERRO IS ABLE TO PROPOSE AND DEVELOP A CUSTOMIZED RELATIONSHIP WITH EVERY CUSTOMER IN ORDER TO SATISFY THEIR NEEDS AIMING TO BE CONSIDERED YOUR WORLD WIDE SOLUTION PROVIDER FOR GUIDE RAIL AND HOISTWAY APPLICATIONS.

MONTEFERRO ITALY CERTIFICATIONS

ISO 9001 - Quality Assurance Certification
 ISO 14001 - Environmental Management Certification



GUIDE RAIL INTERNATIONAL STANDARD

Standard	Guide rail Norm	Raw Material	
		Cold drawn	Machined
ISO	7465	E 235 B	E 275 B
UNI	7465	E 235 B	E 275 B
ANSI	A17-1	--	ASFM-A36
AFNOR	NF P 82/251	E 24-2	E 28-2
JIS	--	--	--
BS	5655/9	4360/40A	4360/43A
DIN	15311	St 37-2	St 44-2

GUIDE RAIL RUST PREVENTATIVES & CLEANERS

Rust preventatives

Type	Thickness	Months outdoors	Months indoors
Tectyl 511 M (oil)	2-10 μ	*	1-3
Tectyl 506 (Wax)	20-30 μ	1-3	6-12
Tectyl 506 (Wax)	40-50 μ	3-6	12-36
Castrol TARP (oil)	02-20 μ	1-3	6-12

Data could change according to environmental humidity and salinity

Cleaners

Type	Solubility in water	Characteristics
SA 120	>50%	Eco cleaner
De-Solv-It 1000	--	Fast cleaner

GUIDE RAIL HANDLING & STORING

Bundles have to be lifted with forklifts or crane by 2 slings from the centre of the bundles, having a minimum distance between the two slings (the lifting points) of 2,2 m, this means to have the lifting points at 1,4 m from each end.

As normal bundle weight range is between 500 and 1.000 kg it is recommended not to lift more than 2 bundles at once. It is anyway preferable to handle one bundle per time.

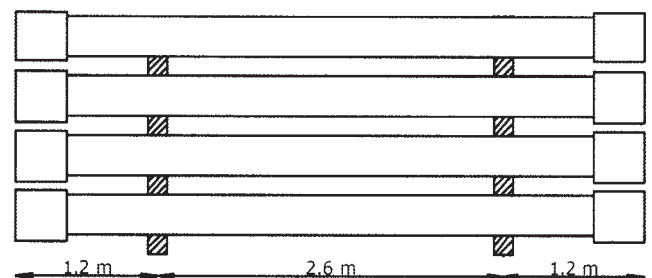
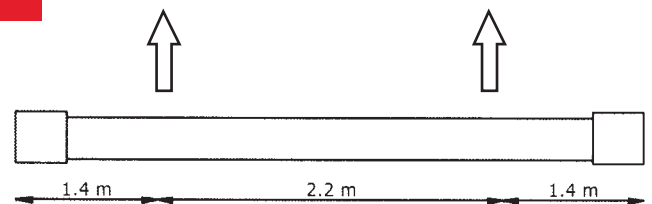

Bundles should be stored horizontally on wooden battens, placed for each level of bundles, at the same distance from the ends. This is important to prevent any permanent deformation of guide rails and loss of linearity properties of the guide rails. The battens distance from bundle ends depend on package solution adopted.

STANDARD GUIDE RAIL BUNDLE PACKING

Monteferro Guide rail Code	ISO Code	Weight per bar (kg)	Number of bars per Standard bundle (pcs)	Standard bundle weight (kg)	Number of bars per full container (pcs)	Accessory set weight (kg)	Num. of bars with accessory set per full container (pcs)
RT 40	--	14,82	54	800	1404	0,51	1350
RT 45	T 45/A	16,77	54	905	1242	0,58	1188
RT 50	T 50/A	18,74	42	787	1134	0,75	1092
RT 70	T 70-2/A	41,51	22	913	506	1,75	484
RT 80	--	53,48	16	856	400	1,97	384
RF 50	--	27,84	42	1169	756	0,75	714
RF 70	T 70-1/A	37,51	22	825	572	1,75	528
RF 70.9	--	44,31	22	975	484	1,68	462
RF 75	T 75-3/A	43,31	22	953	484	1,80	462
RF 65	--	24,58	30	737	870	1,38	810
RF 82	T 82/A	42,98	16	688	496	1,65	480
RF 89	T 89/A	61,73	16	988	336	2,47	320
RF 90	T 90/A	66,74	16	1068	320	2,47	304
RP 75	T 75-3/B	43,31	22	953	484	1,68	462
RP 78	--	38,65	22	850	550	1,68	528
RP 82	T 82/B	42,98	16	688	496	1,65	480
RP 89	T 89/B	61,73	16	988	336	3,09	320
RP 90	T 90/B	66,74	16	1068	320	3,09	304
RP 114	--	82,21	10	822	260	6,10	240
RP 125	T 125/B	90,25	10	903	230	6,10	220
RP 127-1	T 127-1/B	89,31	8	714	240	6,10	224
RP 127-2	T 127-2/B	113,95	8	912	184	6,10	176
RP 127-2 c 14	--	116,90	8	935	176	6,10	168
RP 140-1	T 140-1/B	138,90	4	556	152	12,00	140
RP 140-2	T 140-2/B	169,60	4	678	124	12,00	116
RP 140-3	T 140-3/B	230,00	4	920	92	14,20	88

CUSTOMIZED PROPOSALS

Special packing

Guide rails for high speed application supplied with pre-adjusted joints and numbered with sequential, progressive numbering system by columns. This enhanced manufacturing process allows superior quality with reduced field labour.

Special packing solutions to fulfil Customer logistic needs and guide rail protection:

- Multiple guide rail bundles
- Special protection bundles (frame)
- Special sea packing
- Bundles for guide rail supply with fishplate assembled

Special surface treatments

Painted and zinc coated guide rails and fishplates for Panoramic lift or heavy environmental conditions application

Commission solution

Guide rail bundle and accessory supply for specific lift. Each column for the commission is supplied using standard length guide rails and cut down sizes with length according to the elevator column length. Fishplate mounted, anti-skid supports, customized labels and many other possibilities are available.

Hoistway kit

Hoistway (shaft) material supply for specific lift. The customized Kit solutions include lift specific quantities and types of brackets, pillars, buffers, counterweight, fixing, joining screws, installation kit, etc.

MATCHED GUIDE RAILS FOR HIGH SPEED ELEVATORS

Guide rails for high speed applications supplied with pre-adjusted joints and numbered with a sequential, progressive numbering system by columns. This enhanced manufacturing process allows superior quality with reduced field labour.



Number
One

Italy

Monteferro S.p.A.
Via Como, 11
21020 Monvalle (Varese)
Phone +39 0332 798879
Fax +39 0332 971016
E-mail: customer.service@monteferro.it

Czech Republic

Monteferro Hradek A.S.
Rokycanská 204
33842 Hrádek
Phone +420 371 725467
E-mail: customer.service@monteferro.cz

Spain

Montespain S.L.U.
P. I. Goian
c/San Blas n. 2-B
01170 Legutiano (Álava)
Phone +34 945 291625
Fax +34 945 291626
E-mail: monteferro@montespain.com

Canada/USA

Monteferro America
2840 Wenzel Street
Box 38109 STN Birds Hill
East St. Paul, Manitoba Canada R2E 1H3
Phone +1 204 2220247
Fax +1 204 2244175
E-mail: sales@monteferroamerica.com

Brazil

Monteferro América Latina L.T.D.A.
Rua Soluções do Lar, 200
Jardim do Rio Cotia - Cotia - SP
Brazil, 06716-020
Phone/Fax +55 114777-0998
E-mail: monteferro@monteferro.com.br

India

Monteferro India Guiderails And Elevator Parts
Private Limited
Warehouse:
Site No 70 &71
Balajinagar, Mylasandra,
Mysore Road,
Bangalore-560059
Karnataka State, India
Phone +919739982517
E-mail: kumar@monteferro.it
Web: www.monteferro.in

Monteferro (Hong Kong)

Rm 1110, Concordia Plaza,
1 Science Museum Road,
TsimShaTsui, Kowloon, Hong Kong
Phone: +852 2521 4225
Fax: +852 2526 1393
E-mail: bryan.leung@monteferro.com.hk
E-mail: customer.service@monteferroshanghai.com

